

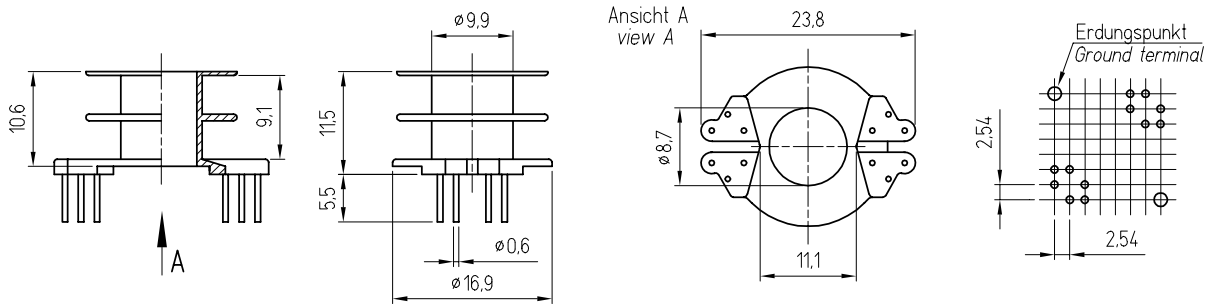

Spulenkörper - nicht-lineare Stiftanordnung  
Coilformer - non linear pin arrangement



	Bezeichnung / description	
	SP - RM 8 - 1071	SP - RM 8 - 1475
Kammerzahl / no. of sections	1	2
$A_N$ in mm <sup>2</sup>	35,8	33,7
$l_N$ in mm	43,6	43,6
max. Stiftzahl / max. no. of pins	12	12
Standardmaterial / standard material	Phenolharz / phenolic resin	
	Applikationsbeispiel / application example	

Spulenkörper - lineare Stiftanordnung  
Coilformer - linear pin arrangement

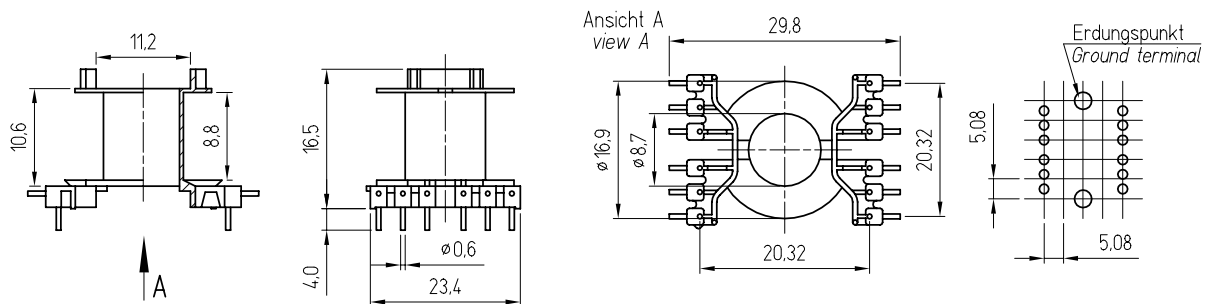

	Bezeichnung / description	
	SP - RM 8 - 1537	
Kammerzahl / no. of sections	1	
$A_N$ in mm <sup>2</sup>	30,8	
$l_N$ in mm	42,2	
max. Stiftzahl / max. no. of pins	12	
Standardmaterial / standard material	Polybutylenterephthalat / polybutyleneterephthalate	
	Applikationsbeispiel / application example	